



ST700TV

TABLETOP SKINNING MACHINE



MODEL

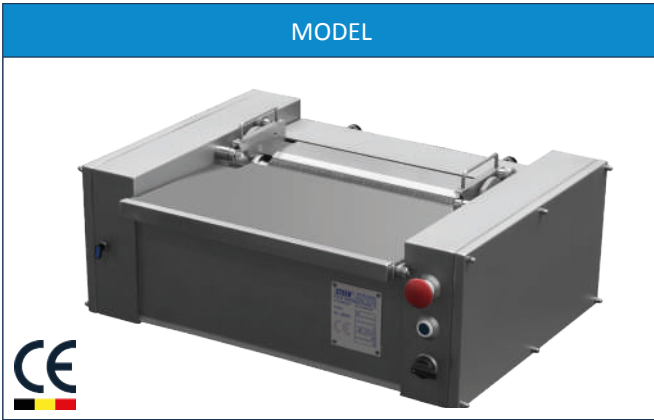

DESCRIPTION

Versatile tabletop skinning machine suitable for many fish species and sizes with the possibility to deep-skin. Please check our website and product matrix on the main folder for more information. When ordering, please provide STEEN with the electrical specifications and water connection available. Also inform us which fish species (preferably the scientific name) you would like to process including capacity and general length. Please also indicate if you have any special requirements regarding the product.

Versátil peladora de sobremesa, adecuada para muchas especies y tamaños de pescado, con la posibilidad de eliminar la piel profunda. Consulte nuestra web y nuestra gama de productos en la carpeta principal para obtener más información. Al realizar el pedido, proporcione a STEEN las especificaciones eléctricas y la conexión de agua disponibles. También infórmenos de las especies de pescado (preferiblemente el nombre científico) que desea procesar, incluidas la capacidad y la longitud general. Indique igualmente si tiene algún requisito especial con respecto al producto.

Versátil máquina de bancada para tirar pele de várias espécies e tamanhos de peixe com a possibilidade de tirar pele mais profunda. Consulte o nosso website e matriz de produtos na pasta principal para mais informação. Ao encomendar, indique à STEEN as especificações elétricas e ligação de água disponível. Informe também que espécies de peixe (de preferência o nome científico) desejaria processar, cada uma delas indicando a capacidade e comprimento geral. Convidamo-lo a indicar-nos quaisquer requisitos especiais que possa ter sobre o seu produto.

TECHNICAL DATA

FEATURE	DATA
Operators	1-2
Voltage range (1)	220- 480V 50-60Hz
Power (1)	0,55kW/3 ph
Controls	24V
LxWxH (2)	610 x 780 x 305 mm
Weight (3)	115 kg
Working width (2)	380 mm
Water usage	2 l/m
Water connection	1/2"
Air usage	-
Air connection	-
Speed (4)	+/- 22 m per minute

(1) depending on requested voltage
 (2) 1mm = 0,03937 inches
 (3) 1kg = 2,20462 pounds

(4) $\frac{2200\text{cm/min}}{\text{length fillet (cm)} + 5\text{cm}}$ = theoretical capacity



FOOTPRINT

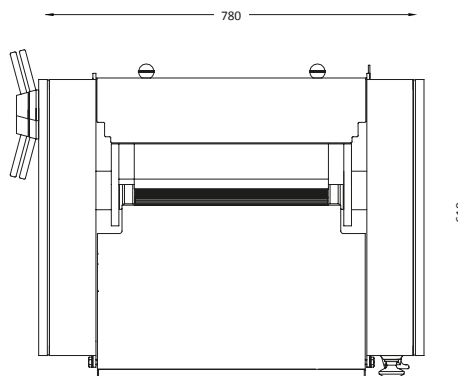

Due to the high degree of customization possibilities, technical data of the final product may vary.







OPTIONS



ST700TV TABLETOP SKINNING MACHINE

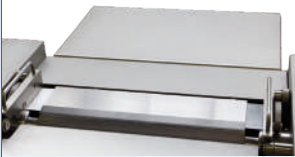

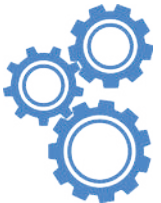
<p>700/3SC603A 1</p>  <p>Skin collector with water drainage</p>	<p>700T/BLADE 2</p>  <p>Extra blade for more possibilities (deepskin)</p>	<p>700T/MONO 3</p>  <p>220V single phase converter</p>	<p>700/3C018 4</p>  <p>Outfeed plate</p>	<p>700/3SC602A 5</p>  <p>Table for machine at optimal height</p>
<p>700/3SC608 6</p>  <p>Water guide in combination with skin collector (1)</p>	<p>700/3K002AS 7</p>  <p>Table for storing knife and disposing blades</p>			<p>CUSTOMIZED 8</p>  <p>Tailor-made solution</p>

Due to the high degree of customization possibilities, technical data of the final product may vary.